

300SR/ST

Operator's Manual



CE

CMW®

Issue 1.0



053-1132

Overview



Chapter Contents

Serial Number Location 2

Intended Use 3

About This Manual 3

- **Bulleted Lists**3
- **Numbered Lists**3
- **“Continued” Indicators**3

FCC Statement 4

Serial Number Location

Record serial numbers and date of purchase in spaces provided. Unit serial number is located as shown.

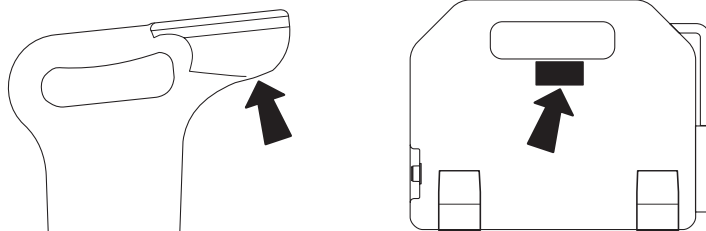

ss1129h.eps

Item	
date of purchase:	
receiver serial number:	
transmitter serial number:	
accessory model & serial number:	
accessory model & serial number:	
accessory model & serial number:	



Intended Use

The 300SR receiver is designed to locate buried pipes, lines, and cables. Several frequencies and modes of operation are available to suit your specific locating needs. Available **passive** modes include 50Hz or 60 Hz power and radio. Available **active** modes include 8 kHz or 29 kHz for use with Ditch Witch transmitters. Available 29 kHz beacon mode is used for locating non-metallic pipes.

The 300ST transmitter places signals on target lines and is used with 300R units. It is configured to send either 8 kHz or 29 kHz frequencies. It places a signal on the line through either direct connection, induction clamping, or broadcast modes.

The unit is designed for operation in temperatures typically experienced in earth moving and construction work environments. Use in any other way is considered contrary to the intended use. The 300 system should be operated only by persons familiar with its particular characteristics and acquainted with the relevant safety procedures. The system should be serviced only by Ditch Witch repair centers.

About This Manual

This manual contains information for the proper use of this equipment. Cross references such as "See page 50" will direct you to detailed procedures.

Bulleted Lists

Bulleted lists provide helpful or important information or contain procedures that do not have to be performed in a specific order.

Numbered Lists

Numbered lists contain illustration callouts or list steps that must be performed in order.

"Continued" Indicators



indicates that a procedure is continued on the next page.

FCC Statement

This device complies with Part 15 of the FCC Rules. Operation is subject to the following two conditions: (1) this device may not cause harmful interference, and (2) this device must accept any interference received, including interference that may cause undesired operation.

Changes or modifications not expressly approved by **The Charles Machine Works, Inc.** could void the user's authority to operate the equipment.

This equipment has been tested and found to comply with the limits for a Class A digital device, pursuant to Part 15 of the FCC Rules. These limits are designed to provide reasonable protection against harmful interference when the equipment is operated in a commercial environment. This equipment generates, uses, and can radiate radio frequency energy and, if not installed and used in accordance with the operator's manual, may cause harmful interference to radio communications. Operation of this equipment in a residential area is likely to cause harmful interference in which case the user will be required to correct the interference at his own expense.

Foreword



This manual is an important part of your equipment. It provides safety information and operation instructions to help you use and maintain your Ditch Witch equipment.

Read this manual before using your equipment. Keep it with the equipment at all times for future reference. If you sell your equipment, be sure to give this manual to the new owner.

If you need a replacement copy, contact your Ditch Witch dealer. If you need assistance in locating a dealer, visit our website at **www.ditchwitch.com** or write to the following address:

The Charles Machine Works, Inc.
Attn: Marketing Department
PO Box 66
Perry, OK 73077-0066
USA

The descriptions and specifications in this manual are subject to change without notice. The Charles Machine Works, Inc. reserves the right to improve equipment. Some product improvements may have taken place after this manual was published. For the latest information on Ditch Witch equipment, see your Ditch Witch dealer.

Thank you for buying and using Ditch Witch equipment.

**300SR/ST
Operator's Manual**

Issue number 1.0/OM-2/07

Part number 053-1132

Copyright 2007

by The Charles Machine Works, Inc.



, Ditch Witch, CMW, AutoCrowd, Modularmatic, Jet Trac, Roto Witch, Subsite, Fluid Miser, Perma-Soil, Power Pipe, Super Witch, Super Witch II, Pierce Arrow, The Underground, and The Underground Authority Worldwide are registered trademarks of The Charles Machine Works, Inc.

Contents



	Overview machine serial number, information about the type of work this machine is designed to perform, basic machine components, and how to use this manual	1
	Foreword part number, revision level, and publication date of this manual, and factory contact information	5
	Safety machine safety alerts and emergency procedures	9
	Controls machine controls and how to use them	13
	Locate procedures for locating active, passive and beacon signals	21
	Locating Concepts basic information for locating active, passive and beacon signals	33
	Service service intervals and instructions for this machine	39
	Specifications machine specifications including weights, measurements and power rating	43
	Support the warranty policy for this machine, and procedures for obtaining warranty consideration and training	47

Safety

Chapter Contents

Guidelines 10

Safety Alert Classifications 11

Safety Alerts 12



Guidelines

Follow these guidelines before operating any jobsite equipment:

- Complete proper training and read operator's manual before using equipment.
- Classify jobsite based on its hazards and use correct tools and machinery, safety equipment, and work methods for jobsite.
- Mark jobsite clearly and keep spectators away.
- Wear personal protective equipment.
- Review jobsite hazards, safety and emergency procedures, and individual responsibilities with all personnel before work begins.
- Replace missing or damaged safety signs.
- Use equipment carefully. Stop operation and investigate anything that does not look or feel right.
- Contact your equipment dealer if you have any question about operation, maintenance, or equipment use.

Safety Alert Classifications

These classifications and the icons defined on the following pages work together to alert you to situations which could be harmful to you, jobsite bystanders or your equipment. When you see these words and icons in the book or on the unit, carefully read and follow all instructions. **YOUR SAFETY IS AT STAKE.**



Watch for the three safety alert levels: **DANGER**, **WARNING** and **CAUTION**. Learn what each level means.

 **DANGER** indicates an imminently hazardous situation which, if not avoided, will result in death or serious injury.

 **WARNING** indicates a potentially hazardous situation which, if not avoided, could result in death or serious injury.

 **CAUTION** indicates a potentially hazardous situation which, if not avoided, may result in minor or moderate injury.

Watch for two other words: **NOTICE** and **IMPORTANT**.

NOTICE can keep you from doing something that might damage the unit or someone's property. It can also alert you against unsafe practices.

IMPORTANT can help you do a better job or make your job easier in some way.

Safety Alerts

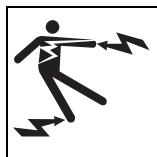

⚠ DANGER Electric shock. Contacting electric lines will cause death or serious injury. Know location of lines and stay away.

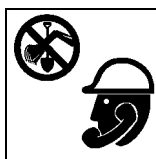

⚠ WARNING Jobsite hazards could cause death or serious injury. Use correct equipment and work methods. Use and maintain proper safety equipment.



⚠ WARNING Explosion possible. Serious injury or equipment damage could occur. Follow directions carefully.

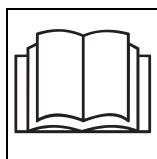

⚠ WARNING Incorrect procedures could result in death, injury, or property damage. Learn to use equipment correctly.



⚠ WARNING Moving traffic - hazardous situation. Death or serious injury could result. Avoid moving vehicles, wear high visibility clothing, post appropriate warning signs.

Controls

Chapter Contents

Receiver	14
• Single-Key Controls	14
• Dual-Key Controls	16
• Display	17
Transmitter	19



Receiver

Single-Key Controls

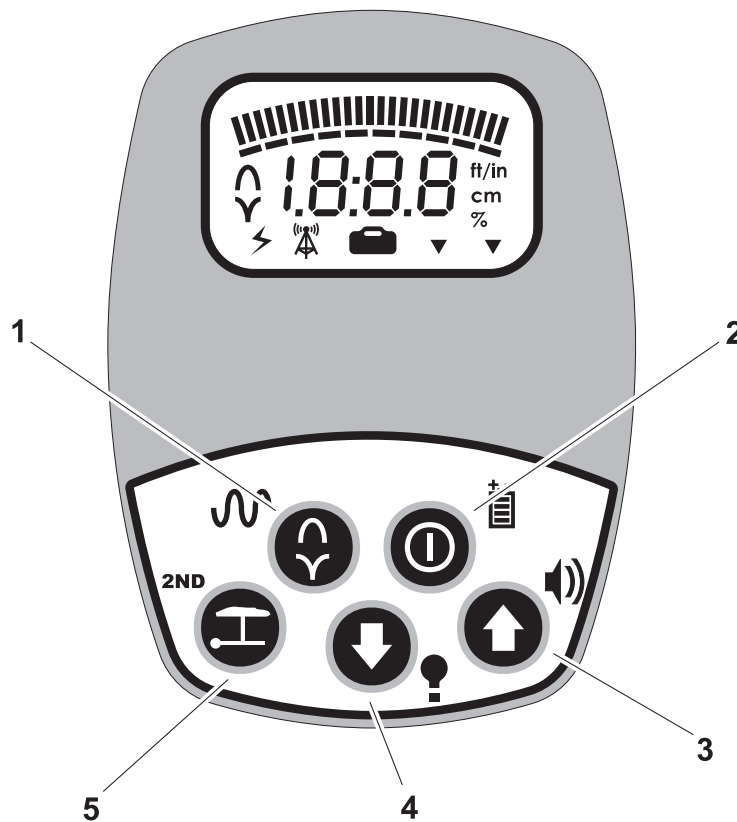

e08om010h.eps

- 1. Antenna select
- 2. ON/OFF
- 3. Up arrow
- 4. Down arrow
- 5. Depth

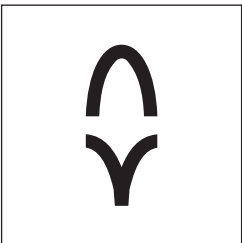
Item	Description	Notes
1. Antenna Select  <small>c00ic444h.eps</small>	To change antenna mode, press. To return to previous mode, press again.	Available antenna modes are peak and null. See "Antenna Configuration" on page 35.

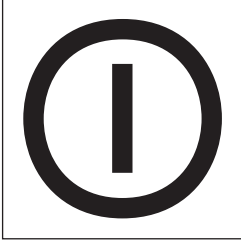
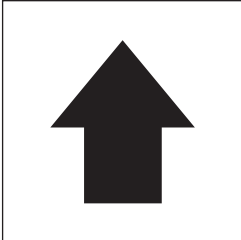
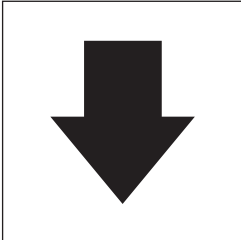
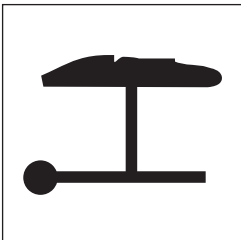
Item	Description	Notes
<p>2. ON/OFF</p>  <p>c00ic427h.eps</p>	<p>To turn on, press.</p> <p>To turn off, press again.</p>	
<p>3. Up Arrow</p>  <p>c00ic429h.eps</p>	<p>To increase gain incrementally from 25 to 100, press.</p> <p>Press and hold to increase gain more quickly.</p> <p>If signal is below 25, press once to increase gain to approximately 50.</p>	
<p>4. Down Arrow</p>  <p>c00ic430h.eps</p>	<p>To decrease gain incrementally from 75 to 0, press.</p> <p>Press and hold to decrease gain more quickly.</p> <p>If signal is above 75, press once to decrease gain to approximately 50.</p>	
<p>5. Depth</p>  <p>c00ic428h.eps</p>	<p>To estimate depth of properly located signal source, press.</p> <p>To enable second functions, press and hold while pressing another button.</p>	<p>See "Double-Key Controls" on page 16.</p>

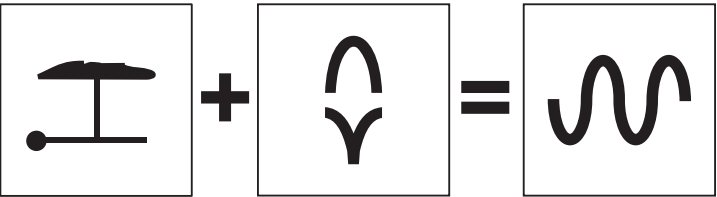
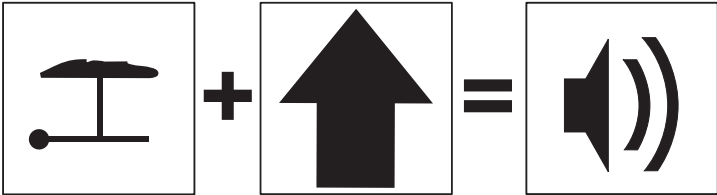
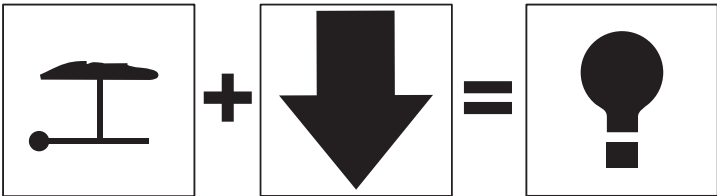

Double-Key Controls

Item	Description
<p>Depth + ON/OFF</p>  <p><small>c00ic447h.eps</small></p>	<p>To show percent of battery life remaining, press indicated keys.</p> <p>To change depth units, press indicated keys with the unit off.</p>
<p>Depth + Antenna Select</p>  <p><small>c00ic445h.eps</small></p>	<p>To cycle through available frequencies, press indicated keys.</p>
<p>Depth + Up Arrow</p>  <p><small>c00ic446h.eps</small></p>	<p>To turn volume on or off, press indicated keys.</p>
<p>Depth + Down Arrow</p>  <p><small>c00ic441h.eps</small></p>	<p>To turn backlight on or off, press indicated keys.</p>

Display

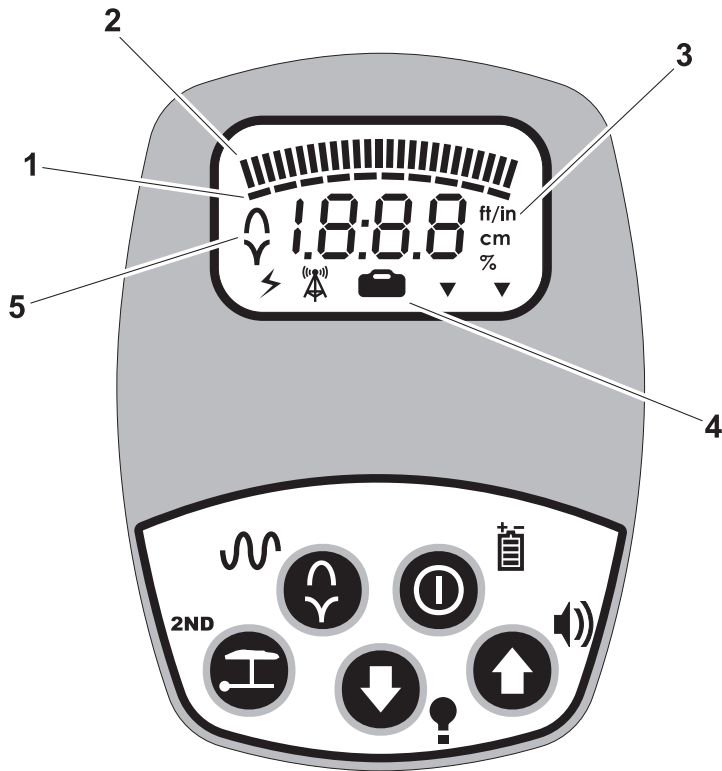

e08om011h.eps

- | | |
|--------------------|------------|
| 1. Gain level | 4. Mode |
| 2. Signal strength | 5. Antenna |
| 3. Depth | |

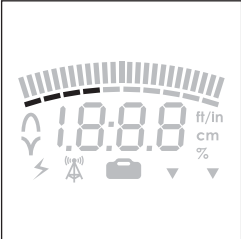
Item	Description	Notes
<p>1. Gain Level</p>  <p>c00ic437h.eps</p>	<p>Graphically indicates gain level.</p>	<p>IMPORTANT: Gain increases to the right.</p> <p>See "Receiver Gain Level" on page 34.</p>

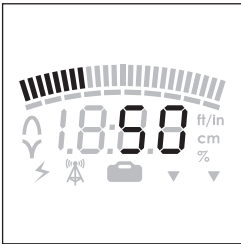
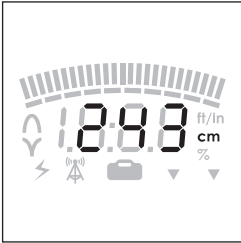
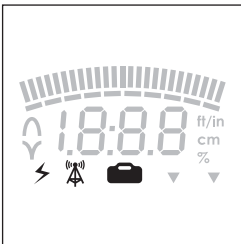
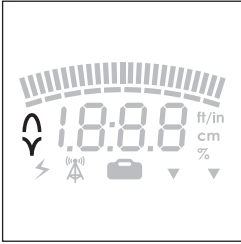
Item	Description	Notes
<p>2. Signal Strength</p>  <p>c00ic438h.eps</p>	<p>Numerically and graphically indicates the signal strength level.</p>	
<p>3. Depth</p>  <p>c00ic439h.eps</p>	<p>Displays depth estimate of properly located line.</p>	
<p>4. Mode</p>  <p>c00ic440h.eps</p>	<p>Indicates mode setting.</p>	<p>See "Mode" on page 36.</p>
<p>5. Antenna</p>  <p>c00ic443h.eps</p>	<p>Indicates antenna configuration.</p>	<p>See "Antenna Configuration" on page 35.</p>

Transmitter

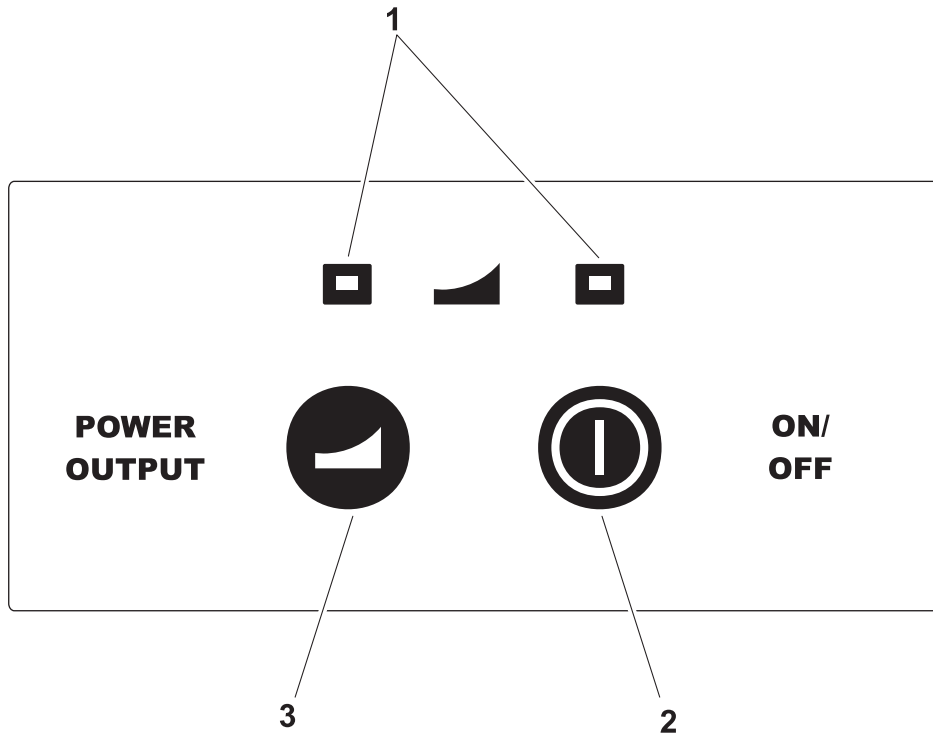

- 1. LEDs
- 2. On/Off
- 3. Power level

Item	Description	Notes
<p>1. LEDs</p>	<p>Green LED indicates low power.</p> <p>Red LED indicates high power.</p>	<p>IMPORTANT: If both LEDs are on, change batteries.</p>
<p>2. On/Off</p>  <p>si1017a-d.eps</p>	<p>To turn on, press.</p> <p>To turn off, press again.</p>	

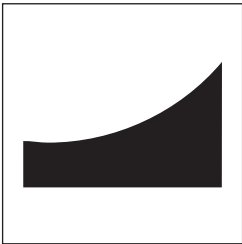
Item	Description	Notes
<p>3. Power Level</p>  <p>c00ic442h.eps</p>	<p>To switch between low and high power, press.</p>	<p>Use low power level to conserve battery.</p>

Locate

Chapter Contents

Active 22

- Setup 22
- Technique 25
- Special Situations 27

Passive 28

- Setup 28
- Technique 30
- Special Situations 30

Beacon 31

- Setup 31
- Technique 31



Active Location

Setup

Follow setup procedures for the type of locating you will be doing: direct connection, induction clamp, or broadcast induction. Always check receiver battery level at startup. See "Controls" on page 13.

Direct Connection

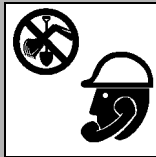

⚠ WARNING

Jobsite hazards could cause death or serious injury. Use correct equipment and work methods. Use and maintain proper safety equipment.

NOTICE: Electric shock or equipment damage can result if transmitter is connected to live cable. Contact qualified utility personnel and follow all standards and requirements for disconnecting and grounding lines.

To set up transmitter for direct connection:

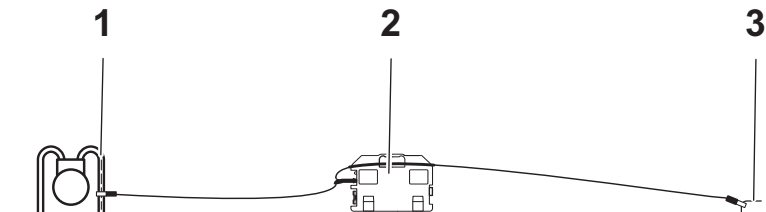

ss0014c-d.eps

1. Carefully push ground stake (3) into ground.
2. Plug cable into transmitter (2).
3. Connect black lead to ground stake.
4. Connect red lead to line (1).
5. Turn on transmitter.

NOTICE:

- Do not unplug direct connect cable when connected to line.
- Turn off transmitter when connecting or moving ground stake.

Induction Clamp



⚠ WARNING

Jobsite hazards could cause death or serious injury. Use correct equipment and work methods. Use and maintain proper safety equipment.

NOTICE: Electric shock or equipment damage can result if transmitter is connected to live cable. Contact qualified utility personnel and follow all standards and requirements for disconnecting and grounding lines.

To set up transmitter for use with induction clamp:

1. Plug cable into transmitter (1).
2. Place clamp around line (2).
3. Turn on transmitter.

NOTICE: Do not unplug direct connect cable when connected to line.

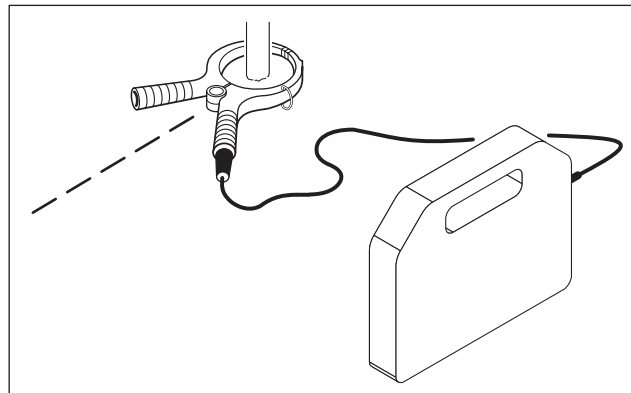

e08om013h.eps



Broadcast Induction

To set up transmitter for broadcast induction:

1. Remove cable, stake, clamp and any other metal objects from transmitter.
2. Place transmitter parallel to and directly above suspected line, as shown.

Note: Transmitter must be parallel to object, as shown, in order to produce the best signal.

3. Turn on transmitter.

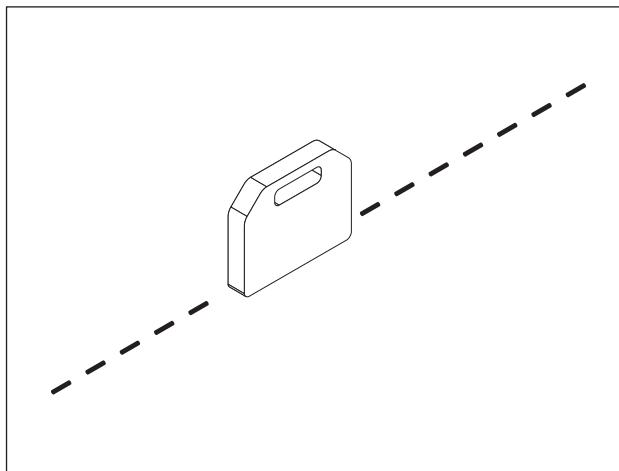

e08om012h.eps

Technique

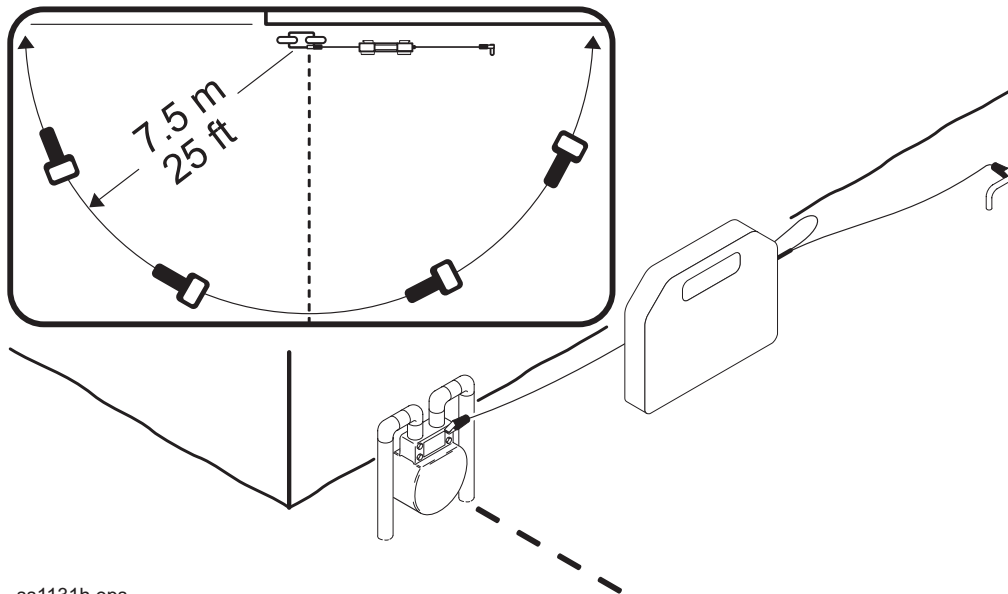

ss1131h.eps

IMPORTANT: Follow steps 1-3 for all types of active location. For reference, the illustration above shows direct connection method. If using broadcast induction, ensure that transmitter is in line with and above suspected line, as shown on previous page.

1. Walk in an arc approximately 25' (7.5 m) around transmitter.
2. Hold the receiver as shown.
3. Identify location of line by finding the spot with the best signal response.



4. Rotate the receiver to determine which direction the line runs.

IMPORTANT: Receiver indicates the best signal when the handle is parallel to the target line.

5. Set receiver on the ground.
6. Press depth button when the line has been located.

IMPORTANT: When estimating depth for pipe, depth shown is to the **center** of the pipe.

7. Continue to trace the line and take depth estimates every few paces.
8. Retrace the line and mark with appropriate flags or paint.

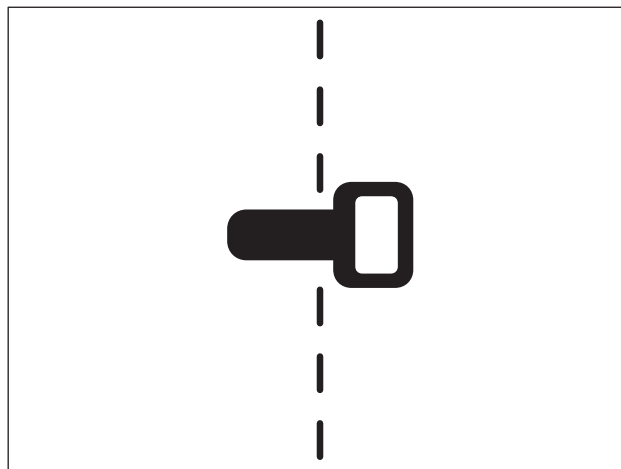

e08om006h.eps

Mark the Line

Sweep, focus, and trace all detected signals in the area. Mark line paths with colored paint or flags. See the chart below for standard color markings for line locations.

Utility	Color	Marking Symbol
electric	red	-E-
gas/oil	yellow	-G-
communications	orange	-TEL- or -TV-
water	blue	-W-
sewer	green	-S-



Special Situations

Situation	What to try
Signal is lost.	Walk in a circle to detect a tee or bend in the line.
Signal varies from low to high and is unstable.	Mark as a hand-dig area.
You are near a power line and are receiving interference.	Sweep the area in power mode. If receiver gives a strong signal response, a power line is interfering with transmitter signal.
Receiver does not function properly.	Receiver gain could be set too high or low. Lower or raise gain to locate the line. See "Controls" on page 13. Also ensure that receiver is set to the correct mode.
Target line has connections to other lines.	Disconnect target line from other lines.
Signal is transferring to other lines.	<ul style="list-style-type: none"> • Lower the power level. • Use direct connection, if possible, or use induction clamp. • Move the ground stake away from the target line and away from other buried lines. • Apply signal at the point where the target line is farthest from the other lines.

Focus the Signal

Move receiver over detected signal to find best signal response. If using a peak antenna mode, rotate receiver until signal is strongest. Best signal indicates line direction.

NOTICE: Keep receiver level.

Trace the Line

Walk along the suspected path while moving the receiver from side to side across the area.

IMPORTANT: Keep receiver handle **perpendicular** to the suspected line path.

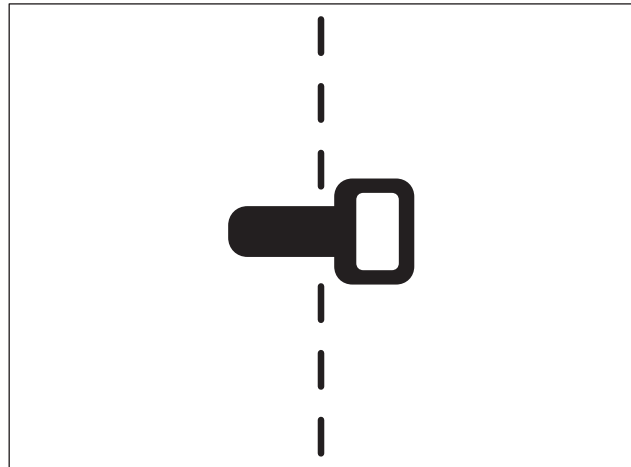

e08om006h.eps



Mark the Line

Sweep, focus, and trace all detected signals in the area. Mark line paths with colored paint or flags. See the chart below for standard color markings for line locations.

Utility	Color	Marking Symbol
electric	red	-E-

Special Situations

Situation	What to try
Signal is lost.	Walk in a circle to detect a tee or bend in the line.
Signal varies from low to high and is unstable.	Check the transmitter connection. If connection is good and signal is still unstable, mark as a hand-dig area.
Receiver does not function properly.	Receiver gain could be set too high or low. Lower or raise gain to locate the line. See "Controls" on page 13.

Beacon Location

Trace metallic or non-metallic pipes or conduits by locating and following a beacon signal.

IMPORTANT: Large metal objects and other signals (such as railroad signals or overhead power lines) will distort signal.

Setup

To set up for beacon location:

1. Follow instructions for installing beacon battery.
2. Turn on receiver to ensure that beacon is functioning properly.
3. Attach beacon to plumber's snake or flex rod.



Technique

1. Turn on receiver.
2. Set antenna to peak and frequency to beacon mode.
3. Place beacon into the pipe and move it down the pipe.
4. To locate beacon, circle over its approximate location in the pipe.
5. To identify the location of beacon, find the spot with the strongest signal response.
6. Rotate the receiver to determine which direction beacon runs.

IMPORTANT: Receiver indicates the best signal when handle is parallel with and directly over the beacon.

7. Press the depth button.

NOTICE: When estimating depth with a beacon in nonmetallic pipe, depth shown will be to the center of the beacon, not to the top of the pipe.

8. Continue to track beacon. Mark pipe location with paint.

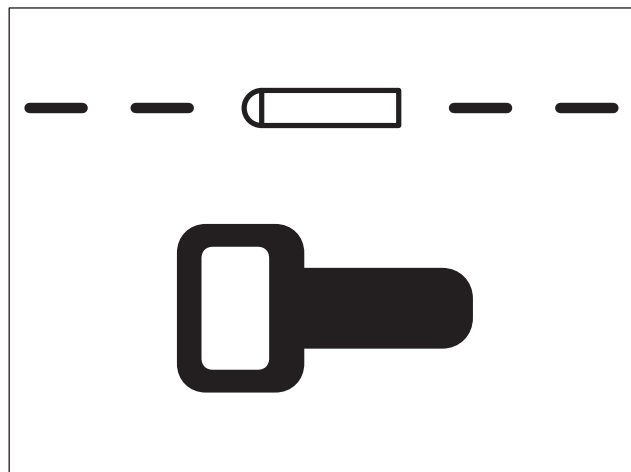

e08om007h.eps

Locating Concepts

Chapter Contents

Signal Type	34
• Active	34
• Beacon	34
• Passive	34
Receiver Gain Level	34
Antenna Configuration	35
Frequency	35
Mode	36
Common Signal Problems	37
• Shadows	37
• False Signals	37
• Secondary (Ghost) Signals	37



Signal Type

The 300SR can detect two types of signals:

- Active signals are placed on a target line with a transmitter and detected by the receiver. As an option, an active signal from a beacon can also be detected by the receiver.
- Passive signals reside on the target line and are read by receiver.

Active

There are three ways to place active signals on a target line with a transmitter:

- Direct connection (preferred method) requires a connection to be made directly onto target line.
- Induction requires placing an optional induction clamp around target line.
- Broadcast method uses a built-in antenna to broadcast a signal onto lines near the transmitter.

Beacon

Beacon signals allow non-metallic pipe tracing.

Passive

Power line signals can be detected passively without a transmitter.

Receiver Gain Level

The receiver gain setting controls the sensitivity to the signal.

Action	Result	Effect
increasing gain	more sensitive to signal	allows location farther away from signal source
decreasing gain	less sensitive to signal	stabilizes signal

Antenna Configuration

The receiver has two antenna configurations.

Twin Peak

Uses two horizontal antennas to detect signal. Response is highest at strongest signal.

Null

Uses a vertical antenna to detect signal. Search width is narrower than peak. Response is lowest when receiver is over the line.

Advantages/Disadvantages

Read the descriptions below and determine the antenna configuration that best fits your job.

Antenna	Advantages	Disadvantages
twin peak	more range	less precise
null	sharp response	easily distorted in congested areas



Frequency

Transmitter



The 300ST transmitter is configured to send either 8 kHz or 29 kHz frequency signals.

Receiver

The 300SR receiver is configured to receive either 8 kHz or 29 kHz active signals, as well as radio and 50 Hz or 60 Hz (power) signals.

Mode

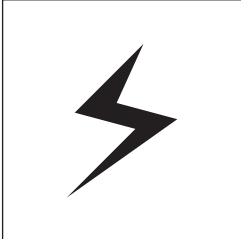
The 300SR receiver has four available mode options.

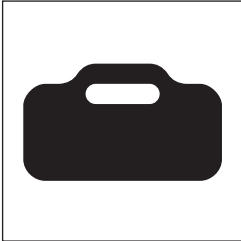
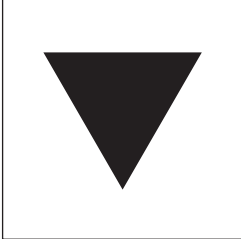
Mode	Description	Notes
<p>Power</p>  <p>c00ic431h.eps</p>	<p>Allows receiver to trace live 50 Hz or 60 Hz power lines.</p>	<p>IMPORTANT: Current must be flowing through the line.</p>
<p>Radio</p>  <p>c00ic432h.eps</p>	<p>Allows receiver to trace lines that pick up and radiate very low frequency (VLF) radio waves.</p>	
<p>Transmitter</p>  <p>c00ic433h.eps</p>	<p>Allows receiver to trace lines that have had an 8 kHz or 29 kHz signal placed on them by a transmitter.</p>	
<p>Beacon</p>  <p>c00ic434h.eps</p>	<p>Allows receiver to trace nonmetallic pipes and conduits with a 29 kHz beacon.</p>	<p>This mode is optional.</p>

Common Signal Problems

Distortions in the electromagnetic field around a line can affect location accuracy. Tees, bends, parallel lines, crossing lines, or large metallic objects can distort signals.

IMPORTANT: If target depth and location are critical, confirm by hand-digging or vacuum excavation.

Learn to recognize the following kinds of distortion:

Shadows

Shadows, also called blind spots, often happen when a metallic object partially obstructs signal, or a signal from a parallel line interferes with target signal.

False Signals

False signals describe situations where the receiver indicates a line location where there is no line. False signals often happen when a line tees or bends, runs parallel to the target line, or crosses the target line.

IMPORTANT: Generally, the receiver shows less distortion in peak antenna configuration.

Secondary (Ghost) Signals

A typical beacon signal pattern shows a main signal and two weaker secondary signals. Identify beacon location at the main signal. Familiarity with beacon signal patterns will lessen the effect of ghost signals.

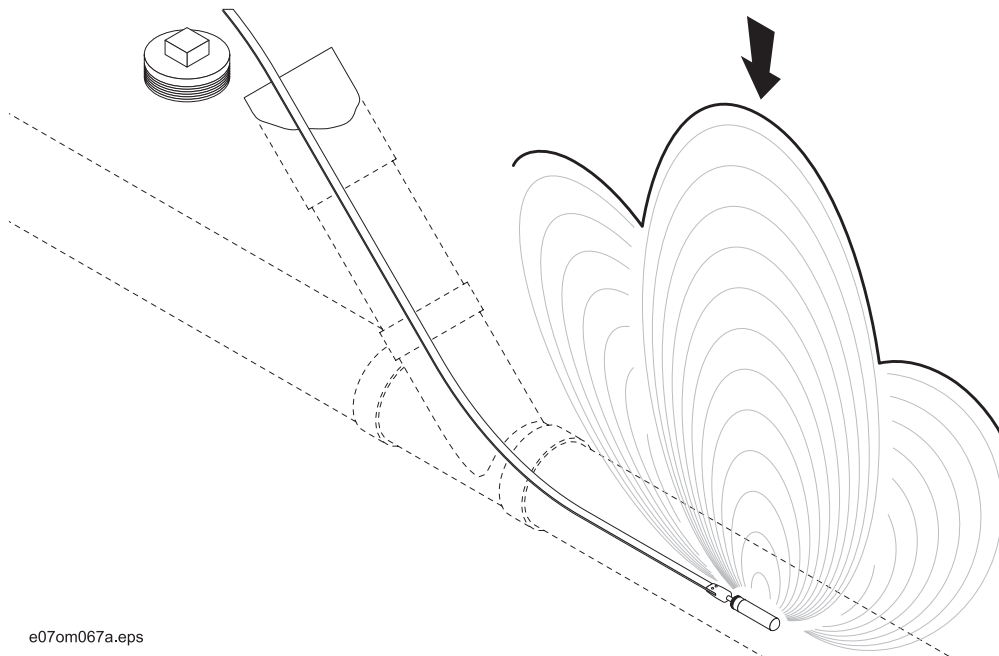

e07om067a.eps



Service



Chapter Contents

General Care	40
As Needed	40
Transmitter Error Messages	41
Receiver Error Messages	42

General Care

Under normal operating conditions, receiver needs only minor maintenance. Following these care instructions can ensure longer equipment life:

- Do not drop the equipment.
- Do not expose the equipment to high heat (such as in the rear window of a vehicle).
- Clean equipment with a damp cloth and mild soap. Never use scouring powder.
- Do not immerse in any liquid.
- Inspect housing daily for cracks or other damage. If housing is damaged, contact your equipment dealer for replacement.
- Do not mix new and used batteries.

As Needed

Location	Task	Notes
Receiver Unit	Change batteries	6 "C" batteries
Transmitter Unit	Change batteries	6 "D" batteries

Receiver Unit

Change Batteries

Use six C-cell alkaline batteries in receiver.

1. Open battery cover.
2. Insert batteries as shown.
3. Close cover and tighten battery cover.
4. Check operation.

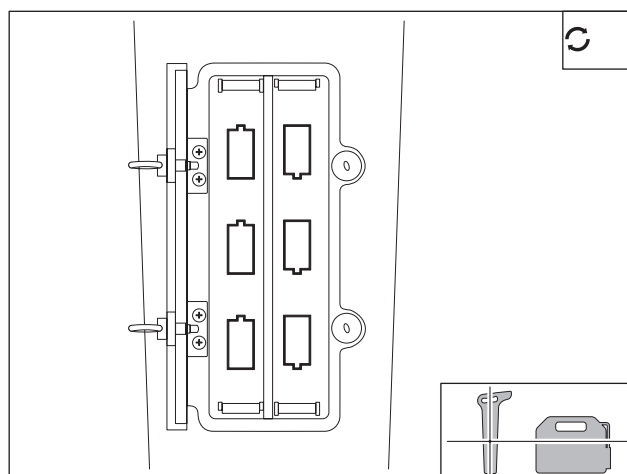

e08om004h.eps

Transmitter Unit

Change Batteries

Use six D-cell alkaline batteries in transmitter.

1. Open battery cover.
2. Insert batteries as shown.
3. Close cover and tighten battery cover.
4. Check operation. If battery light is flashing when unit is turned on, then one battery is incorrectly installed or batteries are weak.

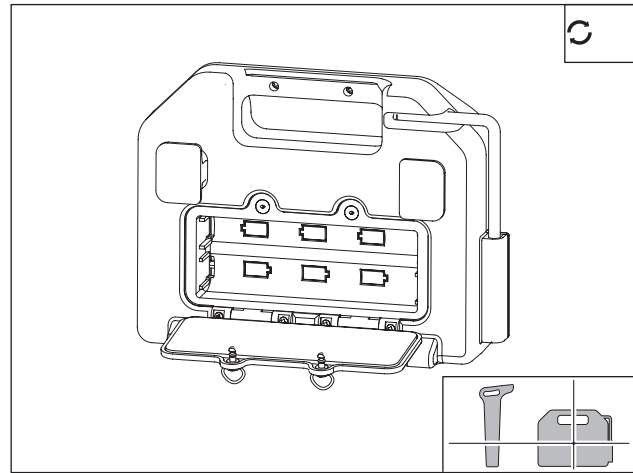

e08om005h.eps

Transmitter Error Messages

Red LED with No Tone

If red LED flashes with no tone in direct connect or induction clamp mode, the unit has detected a short in one of the leads or on the target line.



Receiver Error Messages

Three Dashes

If three dashes appear in the display when pressing the depth button, one of the following could be possible:

- The receiver is detecting a signal above it and cannot estimate depth. This message is usually caused by interfering signals. Try relocating target signal.
- Line is too deep for depth estimate. Mark as hand-dig area.
- Line is too shallow for depth estimate. Select lowest usable transmitter power level or lift receiver high enough to return display to normal operation. Relocate line and verify with null antenna.

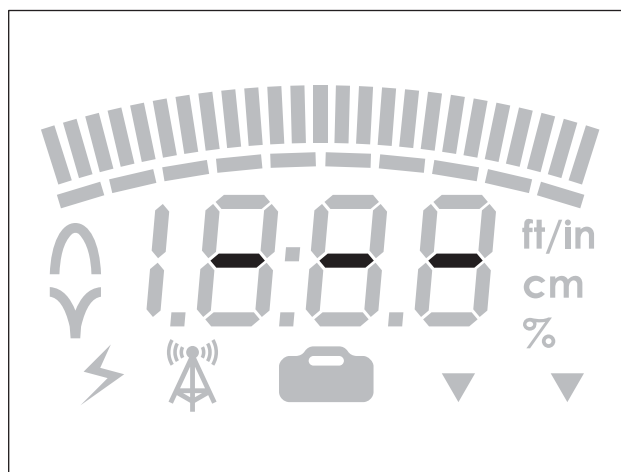

e08om008h.eps

Three Dots

If three dots appear in the display when pressing the depth button, contact your equipment dealer.

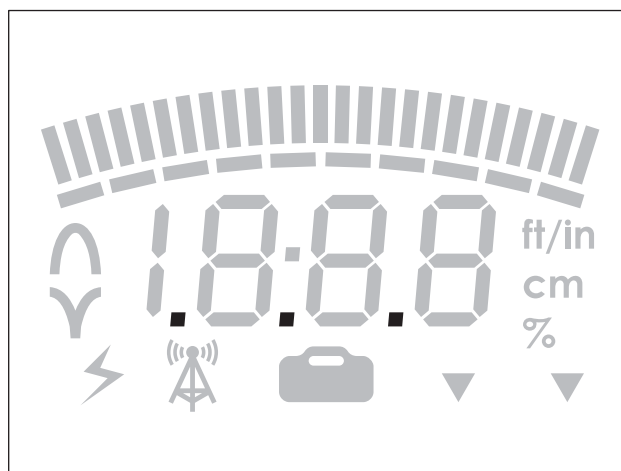

e08om009h.eps

Specifications

300 Receiver

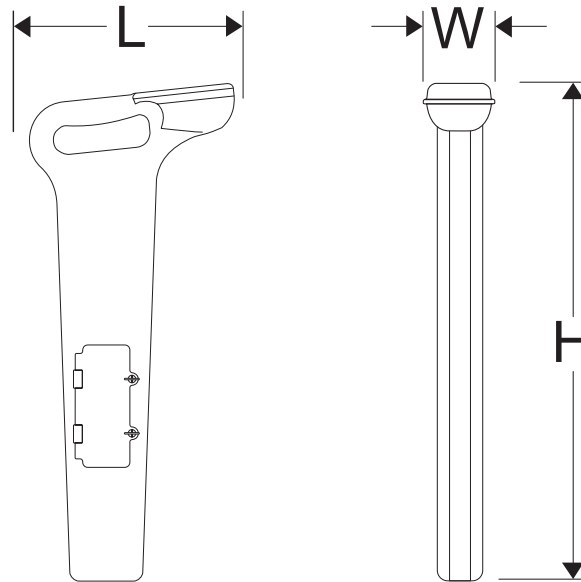

ss1127h.eps

Dimensions		U.S.	Metric
H	Height	27.5"	700 mm
L	Length	11.5"	290 mm
W	Width	4"	100 mm
	Weight	5 lb	2.3 kg
Operation		U.S.	Metric
Operating temperature range		-4°F to 122°F	-20°C to 50°C
Antenna configurations: peak, null			
Audio output: speaker			
LCD backlight: LED (green)			
Batteries			
Type: 6 C-cell alkaline			
Life (intermittent use at 70°F/21°C): approximately 40 hours			
Battery saver: unit shuts off after 5 minutes of inactivity			

300 Transmitter

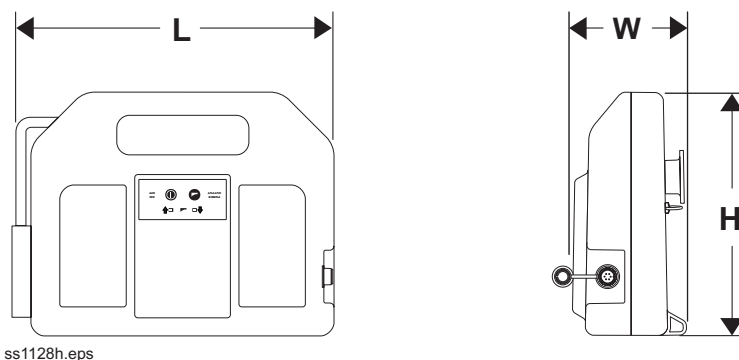

ss1128h.eps

Dimensions		U.S.	Metric
H	Height	9.25"	235 mm
L	Length	12.25"	311 mm
W	Width	4.5"	114 mm
	Weight	5 lb	2.3 kg
Operation		U.S.	Metric
Operating temperature range		-4°F to 122°F	-20°C to 50°C
Maximum power output: 1 watt			
Standard operating modes: 8 kHz or 29 kHz			
Batteries			
Type: 6 D-cell alkaline			
Life (continuous use at low power level): approximately 150 hours			

System Operation

Operating Modes and Frequencies

Active line: 8 kHz or 29 kHz

Passive line (locate only): 50 Hz or 60Hz

Beacon (locate/depth only): 29 kHz

Radio (locate only)

Locating Ranges

Lines	15'	4.6 m
Beacons	10'	3 m

Depth Estimate Tolerances*

Active line $\pm 5\%$	0.5-10'	0.15-3 m
Active line $\pm 10\%$	10' +	3 m +
Beacon $\pm 5\%$	0.5-10'	0.15-3 m

* Locators are calibrated to these tolerances under ideal test field conditions. Actual operating field conditions may have signal distortions or may contain noise sources which result in depth range that is less than specified.



Support



Procedure

Notify your dealer immediately of any malfunction or failure of Ditch Witch equipment.

Always give model, serial number, and approximate date of your equipment purchase. This information should be recorded and placed on file by the owner at the time of purchase.

Return damaged unit to dealer for inspection and warranty consideration if in warranty time frame.

All repairs must be done by an authorized Ditch Witch repair facility. Repairs done elsewhere will void warranty consideration.

Resources

Publications

Contact your Ditch Witch dealer for publications and videos covering safety, operation, service, and repair of your equipment.

Training

For information about on-site, individualized training, contact your Ditch Witch dealer.

Warranty

Limited Product Warranty Policy

Warranty Periods

New Product

A twelve-month period starts on the date of delivery to the end user:

trackers, remote displays, receivers, transmitters, radars, fault finders

A six-month period starts on the date of delivery to the end user:

directional and locate beacons

A three-month period starts on the date of delivery to the end user:

accessories: cables, clamps, canoes, bags, and adapters

Used Product (Cosmetics)

A three-month warranty starts on the date of delivery to the end user on used and refurbished products sold from Ditch Witch Electronics dealers. Used products are non-returnable.

Service and Repair

A one-month warranty on **labor** starts on the date the unit is repaired, and a three-month warranty on **parts** starts on the date the unit is repaired for all products.

Extended Warranty

The extended warranty may be purchased at the time the equipment is sold or anytime within the original warranty period. The extension is for an additional twelve or twenty-four months, for a total coverage of twenty-four to thirty-six months. Exclusions: All beacons and accessories.

Details and Exclusions



- The warranty includes only Ditch Witch Electronics products and accessories that are manufactured and distributed by Ditch Witch Electronics. The warranty compensates on defects in material or workmanship.
- Defects will be determined through inspection by Ditch Witch Electronics or authorized repair centers. Original purchaser must make the defective item available for inspection within 30 days of the date the part fails.
- The warranty is limited to replacement of the defective part. The replacement part may be new or remanufactured. Repair and installation of defective part will be at no charge when product or item is delivered to Ditch Witch Electronics or an authorized repair center. The product or item will be returned at no charge for return freight.
- The warranty periods do not represent the useful life of Ditch Witch Electronics products and accessories.
- If Ditch Witch Electronics products are purchased for commercial purposes, as defined by the Commercial Code, no warranties extend beyond the specific terms set forth in this limited warranty. All other provisions of this limited warranty apply, including the duties imposed.
- Ditch Witch Electronics products have been tested to deliver acceptable performance in most conditions.
- This limited warranty applies to the original purchaser only. Some states or jurisdictions do not allow exclusion or limitation of incidental or consequential damages, so above limitation may not apply. This limited warranty gives original purchaser specific rights that vary from state to state or jurisdiction to jurisdiction.
- Each serial-numbered piece of equipment must be registered by the selling dealer to determine warranty start date.
- When a registration is not received, the Ditch Witch Electronics shipping date is used to establish the warranty period start date.
- Product inspection and estimates may require that the unit be disassembled and tested.
- Out-of-warranty inspection costs include labor accrued at the full labor rate plus return freight.
- Approved out-of-warranty repair costs include parts, labor accrued at full labor rate, plus return freight.

